



Rénovation avec une ventilation par pièce
«LEGENDÄR by REKA» à Zermatt

«Naturfreunde Hotel» avant la rénovation



Situé à 50m au dessus du village de Zermatt, le projet est une transformation d'une auberge de jeunesse en 17 appartements de vacances Minergie



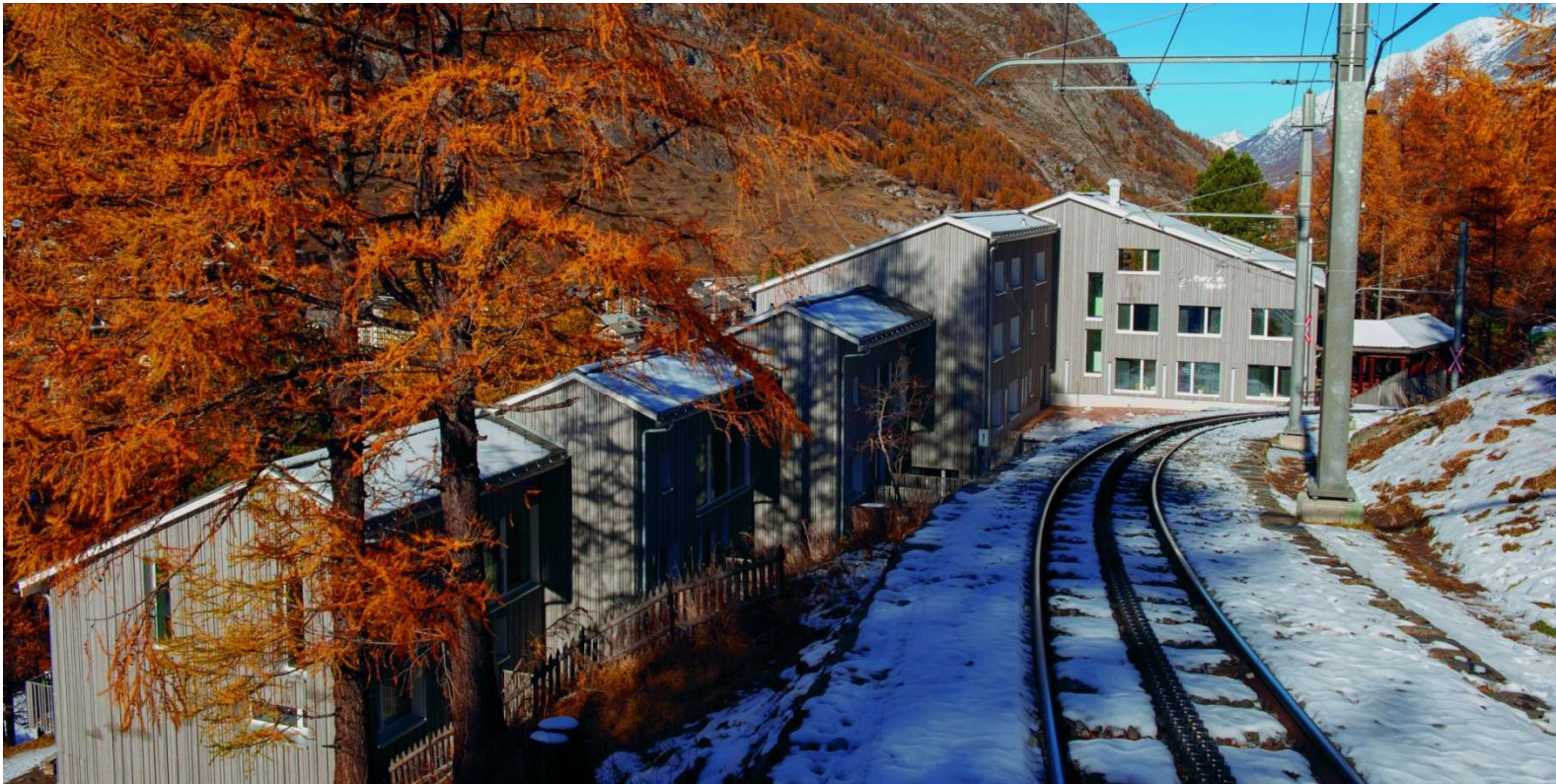

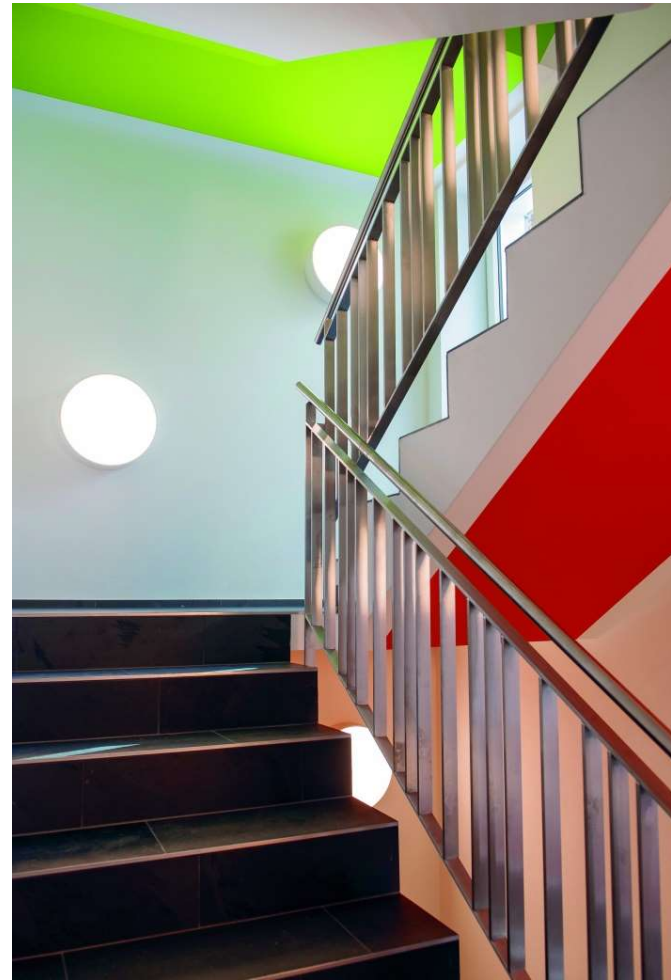





Le projet en chiffres

Caractéristiques du bâtiment

- Surface plancher brut : 2'407 m²
- Volume : 6'360 m³
- Enveloppe : 3'159 m²
- Chaudière pellets 2x 60kW (62kW chauffage, 42kW SPA, 20kW EC)

Le projet en chiffres

- 17 appartements entre 3 ½ - 6 ½
- 107 lits / 58 WC-douches
- Occupation : ~ 35 semaines en moyenne / an

- Début du chantier : Avril 2013
- Ouverture pour des clients REKA : 19 Décembre 2014



Pose des appareils de ventilation par pièce

- 47 appareils Air-ON



Schéma de principe

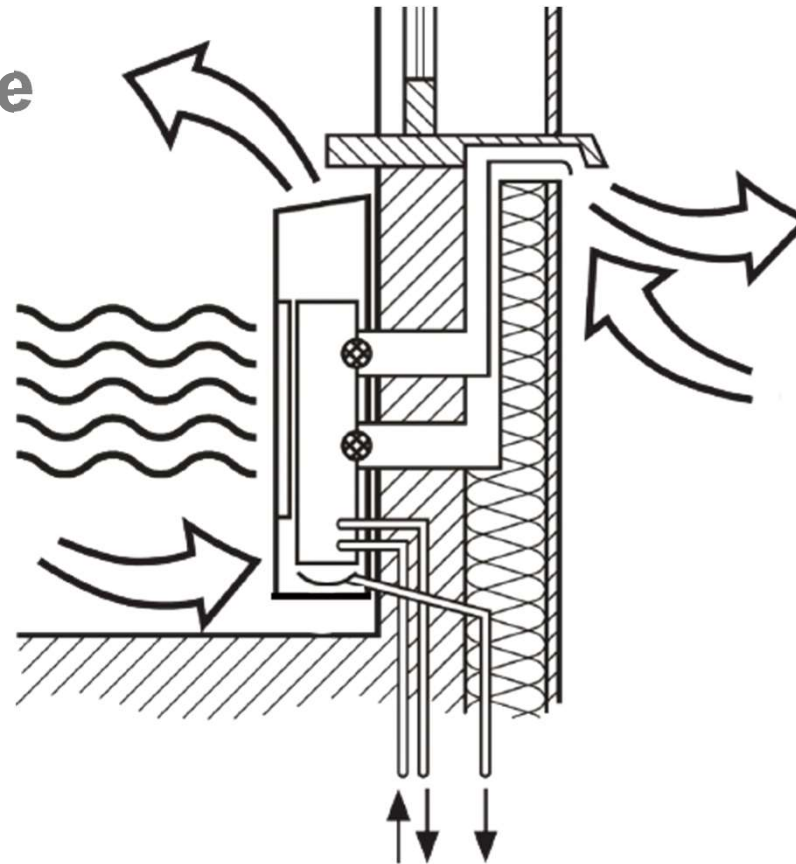

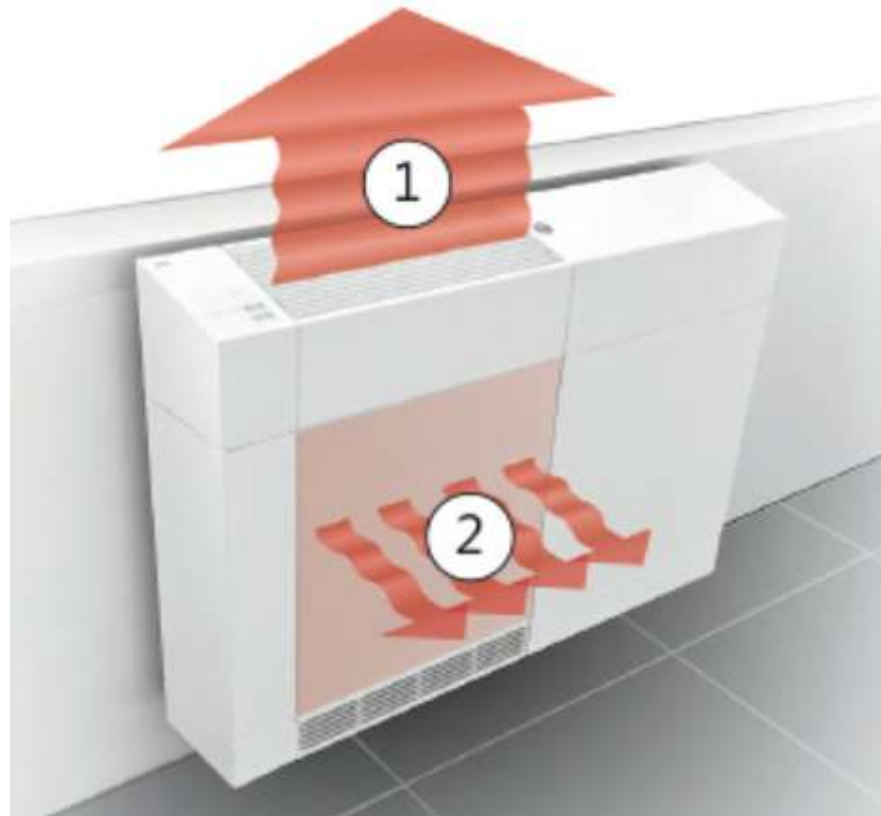

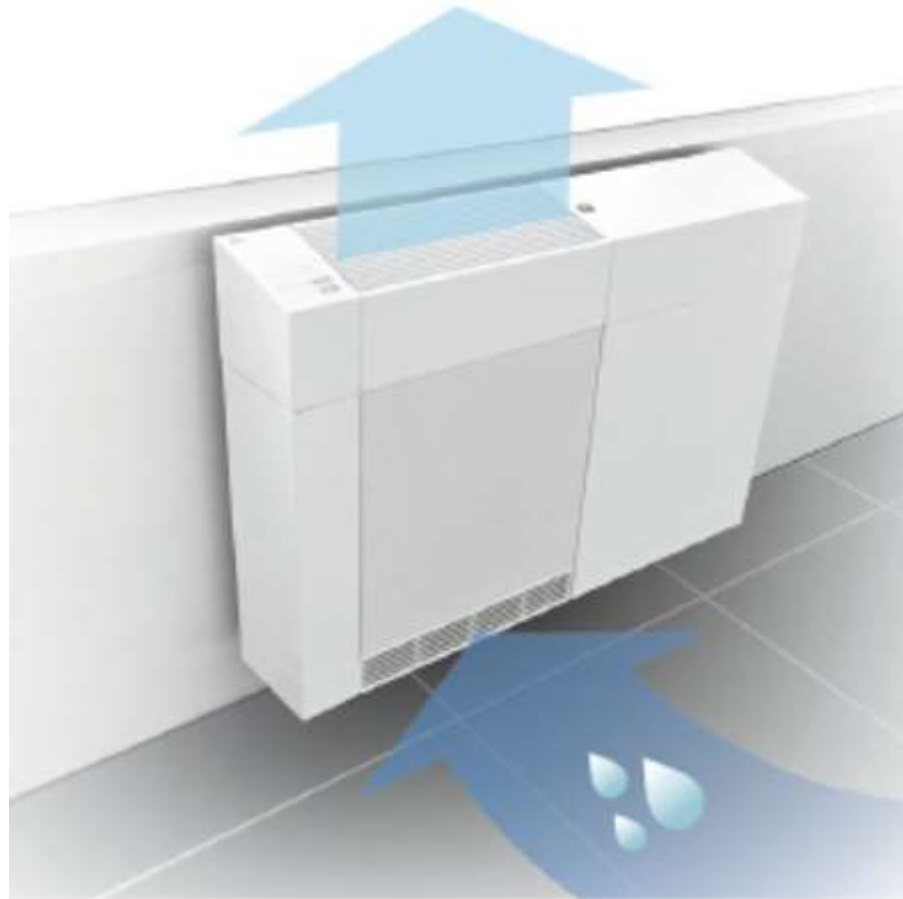



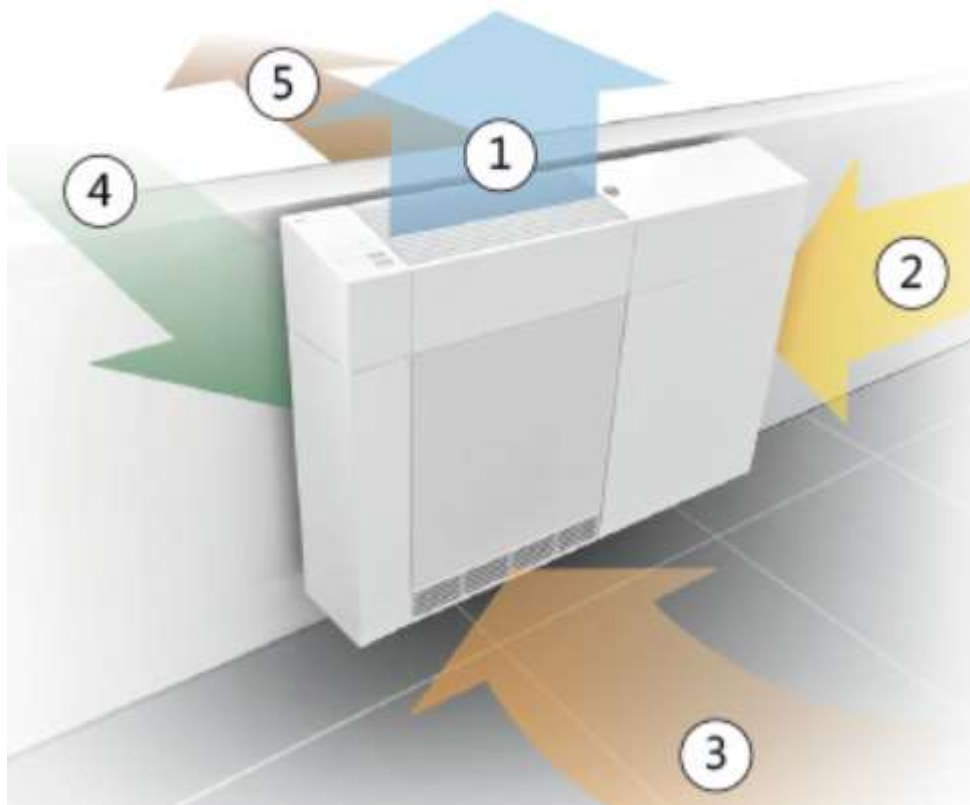

Air-ON













Rehau GENE0-Inovent

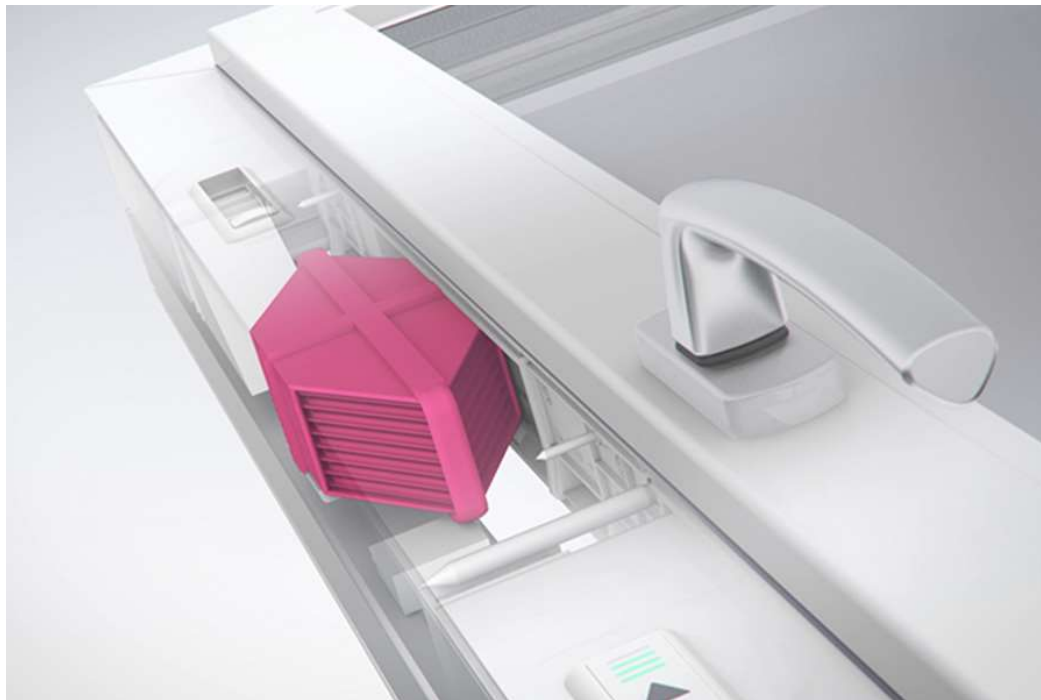

Rénovation à Genolier







Je vous remercie de votre attention

...au revoir sur www.zo2.ch

Sigena Aeromat / EgoFresh - Prolux

